



Description

These integrated termination networks provide high performance line termination designs for both 2.5V & 3.3V LVPECL busses.

Specifically designed shielding inside the package combined with a ceramic substrate virtually eliminates cross talk between channels that is common in other termination networks and resistor arrays.

The BGA packaging has been proven to reduce rework and improve reliability.

Features

- 8 Bit Thevenin Termination Set
- Compliant for LVPECL Termination
- Excellent High Frequency Performance
- Slim BGA Package
- 1% Resistor Tolerance
- Low Channel to Channel Cross Talk
- RoHS Compliant Designs Available
 - Compatible with both lead and lead-free processes

Style G

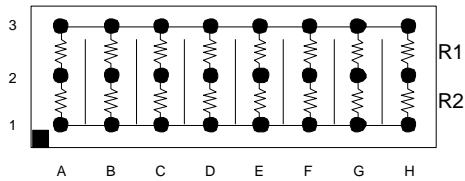

LVPECL Thevenin Termination

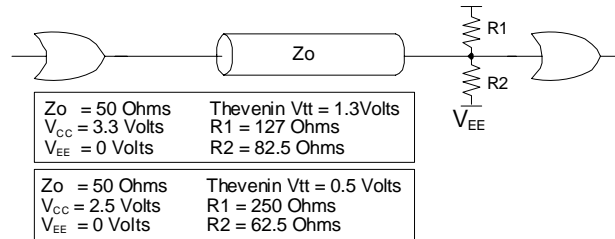

Electrical Specifications

Resistor Tolerance:	$\pm 1.0\%$	
TCR	$\pm 200 \text{ ppm}/^\circ\text{C}$	
Operating Temperature Range	-55°C to +125°C	
Maximum Resistor Power:	B6-1.27mm Pitch	B7-1.00mm Pitch
	RT1250 R1	96mW
	RT1250 R2	60mW
	RT1251 R1	96mW
	RT1251 R2	66mW
	143mW	91mW
	164mW	105mW
Maximum Package Power:	1.0 Watt at 70°C	
Process Requirements:		
Maximum Re-flow Temperature	Per IPC/JEDEC J-STD-020C	

Typical Application

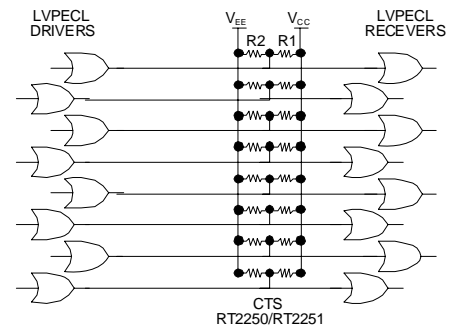

Ordering Information

Standard Part No.	R1 Ω	R2 Ω	Bits	Pitch (mm)	RoHS Part No.
RT1250B6*	127	82.5	8	1.27	RT2250B6*
RT1250B7	127	82.5	8	1.00	RT2250B7
RT1251B6	250	62.5	8	1.27	RT2251B6
RT1251B7	250	62.5	8	1.00	RT2251B7

*Indicates available Top Probe-able part numbers.
 Refer to the following link for detailed Top Side Probe-able information:
www.ctscorp.com/components/clearone/TopProveClearOne.pdf

Packaging Information

Suffix	TR7	TR13
Tape Width	24 mm	24mm
Carrier Pitch	8 mm	8 mm
Reel Diameter	7 inch	13 inch
Parts/Reel	1,000	4,000

Part Number Coding

7 inch reel, Add TR7 to part number, example RT2250B7TR7

13 inch reel, Add TR13 to part number, example RT2250B7TR13

(Bulk packaging is not available)

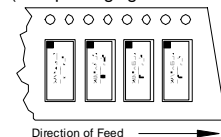

Recommended Land Pattern

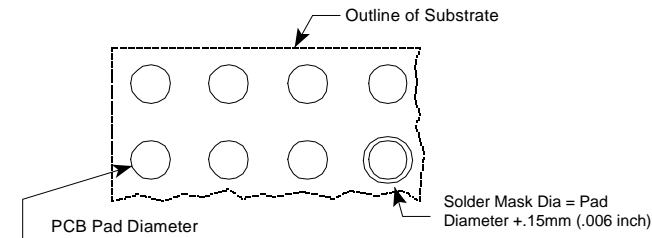

1.00mm Pitch (B7) = 0.51mm/.020 inch (minimum)
1.27mm pitch (B6) = 0.64mm/.025 inch (minimum)

For .006" Thick Solder Paste Stencil, Aperture Opening Should be Equal to the PCB Pad Diameter.

Refer to www.ctscorp.com/components/clearone.asp for additional PCB design information

BGA Routing Scheme

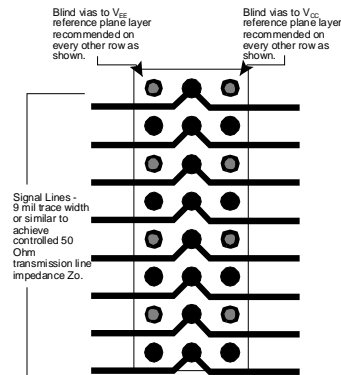

Mechanical Diagram

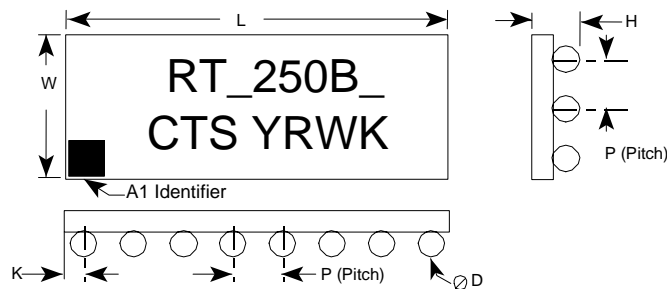

1.00mm Pitch		L	W	H	P	D	K
RT1250B7	mm	8.00±0.15	3.00±0.15	1.19±0.15	1.00±0.25	0.64±0.05	0.50±0.25
RT2250B7							
RT1251B7	inch	.315±.006	.118±.006	.047±.006	.039±.010	.025±.002	.020±.010
RT2251B7							
1.27mm Pitch		L	W	H	P	D	K
RT1250B6	mm	10.16±0.15	3.81±0.15	1.32±0.15	1.27±0.25	0.76±0.05	0.64±0.25
RT2250B6							
RT1251B6	inch	.400±.006	.150±.006	.052±.006	.050±.010	.030±.002	.025±.010
RT2251B6							

Complete ClearONE Product, Processing, and Application Information can be found at the following link:

<http://www.ctscorp.com/components/clearone.asp>