

Features

- Low Insertion Loss
- Low Ripple
- Excellent Rejection

Description

Surface mount, silver (Ag) coated ceramic simplexer. Developed for use in 800 MHz Infrastructure Applications.

Weight: 12.25 grams typical

Material: Filter is composed of a ceramic block plated with Ag and a shield made of Sn plated steel.

Filter complies with RoHS standards.

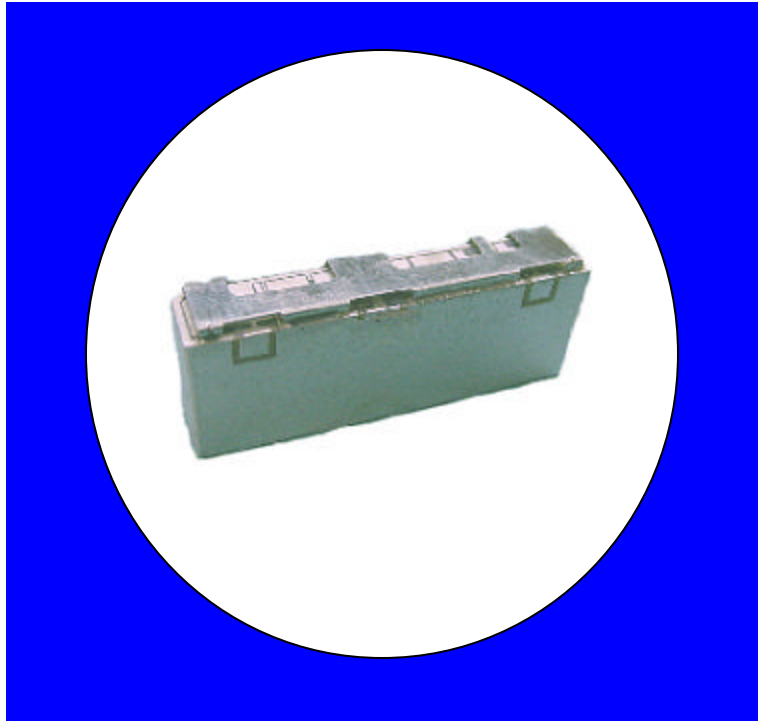

Electrical Specifications

Parameter	Frequency MHz	Typical @ 25°C	Specification @ 25°C	Spec over -30°C to +85°C
Passband Iloss	806 - 902	0.9	-1.1	-1.2
Passband Ripple	806 - 902	0.2	0.5	0.5
Passband Return Loss @ TX	806 - 902	-14.0	-12.0	-12.0
Passband Return Loss @ Ant	806 - 902	-14.0	-12.0	-12.0
Attenuation	0.1 - 756	-28.0	-24.0	-24.0
	952 - 971	-26.0	-24.0	-24.0
	1400 - 1700	-55.0	-45.0	-45.0
	1700 - 1800	-33.0	-30.0	-30.0
	1800 - 1900	-12.0	-10.0	-10.0
Power into any port		1 Watt max		

Note: Supplier shall test each filter to the critical electrical specifications of the above table. Any subsequent audits may deviate from in value due to measurement repeatability among different test systems. Such deviations shall not exceed the following limits:

Specification Allowance	
Insertion Loss	0.1 dB
Return Loss	1.0 dB
Stopbands	1.0 dB

*This product is covered by one or more of the following U.S. and foreign patents including: US 4,692,726;US 4,742,562; US 4,800,348;US 4,829,274;US 5,146,193;EP 0573597;DE 0573597;FR 0573597;P 508149/92;KR 142171;US 5,162,760;US 5,218,329;US 5,250,916;US 5,327,109;US 5,488,335;CA 2114029;FR 9306297;GB 2273393;JP 3205337;KR 115113;CN 93106228.4;US 5,512,866;EP 0706719;DE 0706719;FR 0706719;GB 0706719;CN 95190359.4;US 5,602,518;US 5,721,520;US 5,745,018;EP 0910875;DE 0910875;DK 0910875;FR 0910875;GB 0910875;IE 0910875;JP 50518298;KR 10-323013;US 5,994,978;US 6,462,629;CN 00810420.4;US 6,559,735;US 6,650,202;US 6,834,429. Other US and foreign patents pending.

CTS Corporation 2006 reserves all copyrights in the layout, design and configuration of the patterns on this product.

Mechanical Drawing

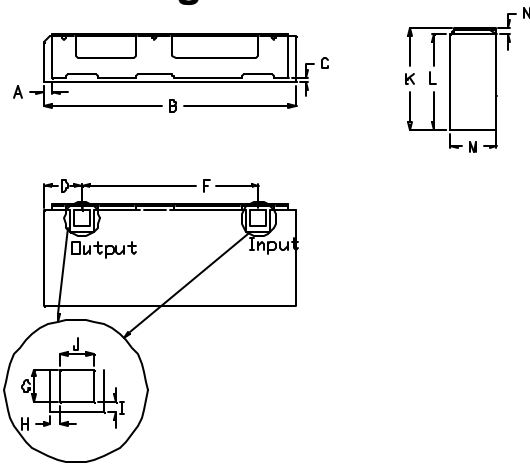

Dimension	Nominal (mm)	Tolerance (mm) +/-
B	33.80	max
D	5.02	0.25
F	23.53	0.13
G	2.03	0.13
H	0.64	0.13
I	0.64	0.13
J	2.03	0.13
K	9.70	max
L	8.70	max
M	6.50	max
N*	0.89	0.13

*Indicates Reference Only

Electrical response

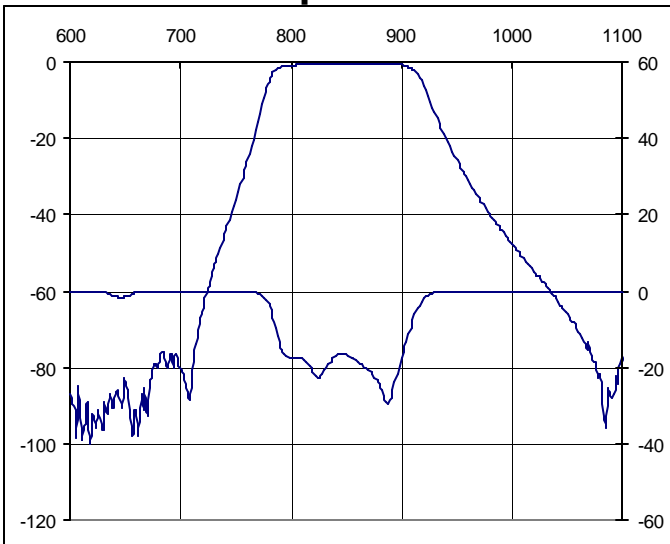

PCB Layout

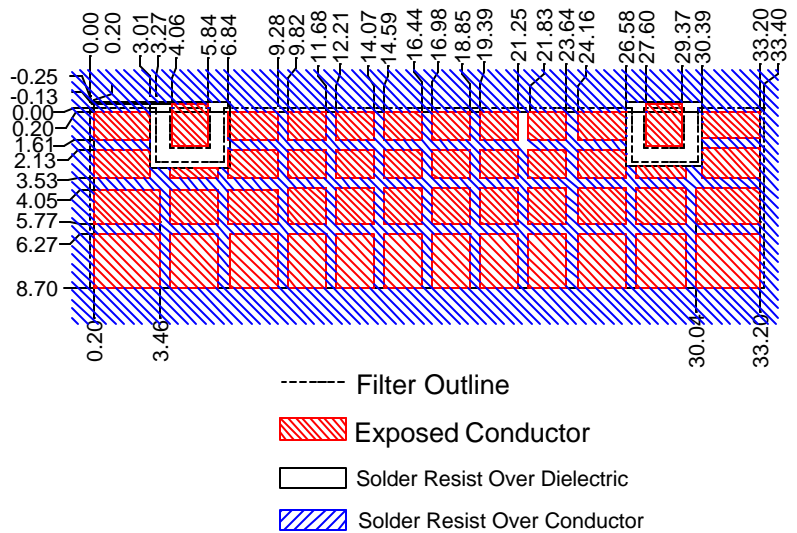

Packaging and Marking

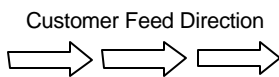

DIMENSION	UNITS	SPECIFICATION
REEL DIAMETER	mm	330
REEL WEIGHT	kg	3.8
REEL QUANTITY	ea.	250

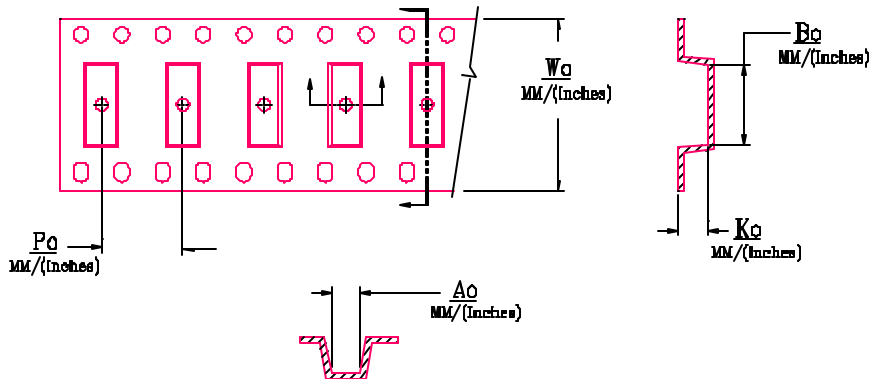
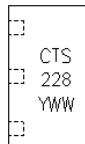

MODEL NO.	W_0	A_0	B_0	K_0	P_0
CERD22B	56.0/(2.205)	8.00/(0.315)	34.10/(1.343)	6.70/(0.264)	18.0/(0.630)